

BONTEMPI®

OFERTAS EXPODENTAL '24

Stand 4C15 Pabellón 4

Del 15 de enero al 1 de abril

 **BONTEMPI**®



NSK

MJK
Instruments

parkell®



SATELEC
ACTEON

JEIL MEDICAL

medipac®
MEDICAL SUPPLIES

DIRECTA



¿Necesitas asesoramiento?

¿Tienes pensado ampliar tu clínica?

¿O quizás abrir una clínica nueva?

¿Quieres que te pasemos a visitar?

No dudes en contactar con nosotros,
queremos aportar a tu proyecto.

BONTEMPI ESPAÑA: 933 450 727 - 607 879 785
david@bontempi.es

KIT BÁSICO DE CIRUGÍA

COMPUESTO POR:

- Caja quirúrgica BS-61
- Pinza de Corn para suturar DA-07
- Periostotomo Freer
- Cucharilla Lucas dentada 720-86M
- Tijera Goldman Fox curva GFC-S
- Separador Farabeuf BT-20
- Pinza Adson S/D BD-31
- Sonda milimetrada a milímetro SM-15
- Pinza Gubia Friedmann FO-16
- Periostotomo Molt MO-10
- Separador Minesota OM-55
- Tijera Spencer SC-1
- Mango Bisturí MAB-1
- Portaguas PH-79

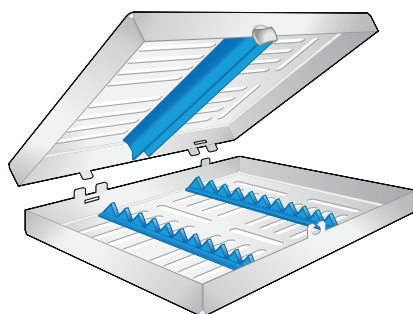

~~825,83€~~

599€



CAJA BÁSICA CURETAS DE SENO

~~468,40€~~

395€

COMPUESTO POR:

- Caja para esterilizar y guardar instrumentos BS-59
- Separador para elefante para liberar la tensión de la membrana MC-2
- Separador para el suelo del seno MC-1
- Separador Mesio-distal 718-EN2
- Separador frontal para elevar la membrana o despegar en caso de existencias de septum EN-M3

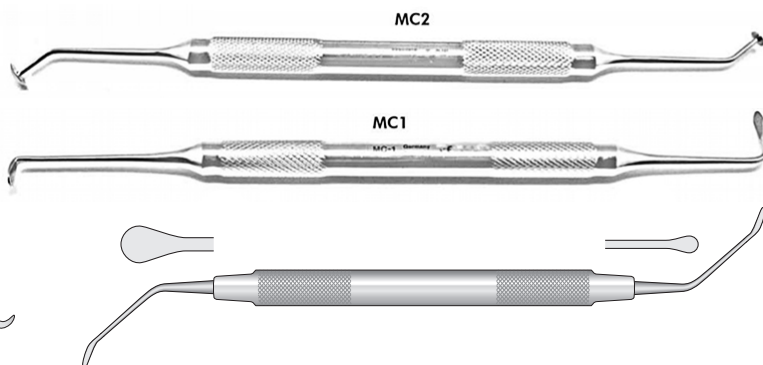
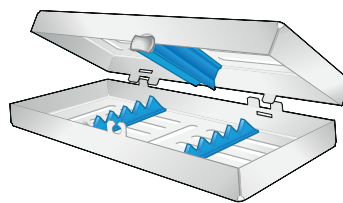

KIT DE OSTEOTOMOS CURVOS

COMPUESTO POR:

- Caja para esterilizar y guardar instrumentos BS-59
- Osteotomo Curvo de 3mm con tope basculante FL-75
- Osteotomo Curvo de 3,3mm con tope basculante FL-76
- Osteotomo Curvo de 4mm con tope basculante FL-77

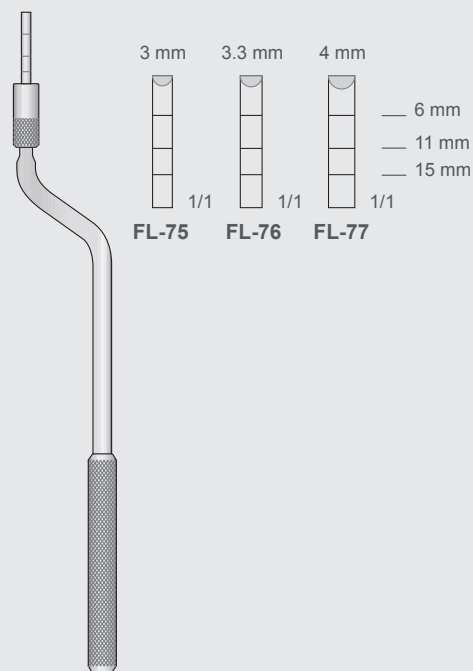
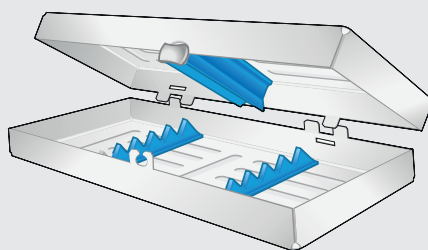

~~653,86€~~

490€

KIT ZAGA

Para Implantes Zigomáticos,
del Dr. Aparicio



~~1.624€~~

1.400€

KIT BÁSICO DE TUNELIZACIÓN

~~938,56€~~

680€

COMPUESTO POR:

- Caja para esterilizar y guardar instrumentos BS-60
- Tunelizador recto Allen UST-MPA
- Tunelizador curvo Allen UST-KPA
- Tunelizador forma de lenteja EP-05
- Portaguijas Castroviejo recto 18cm, mango recto FD-30
- Tijera Castroviejo Curva FD-08

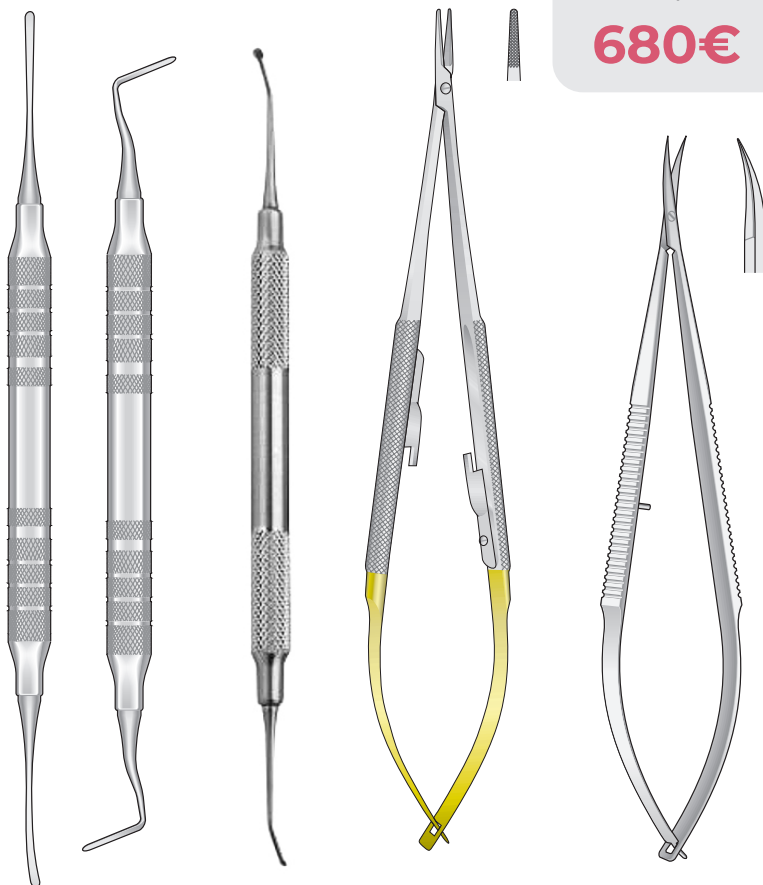
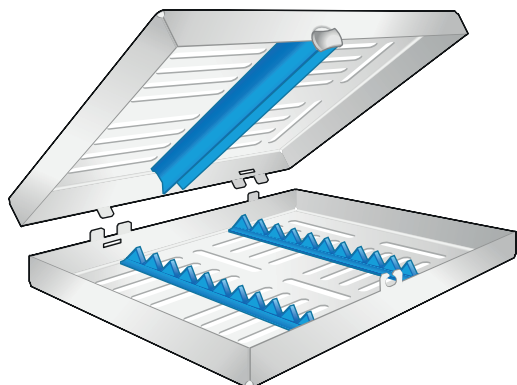

KIT BÁSICO DE CHINCHETAS

~~650€~~

580€

COMPUESTO POR:

- Mini caja para colocar chinchetas 112-082
- Mango 111-010
- Transportador de chinchetas recto 113-JT-103
- Transportador de chinchetas curvo 113-JT-101
- 10 chinchetas de 3mm

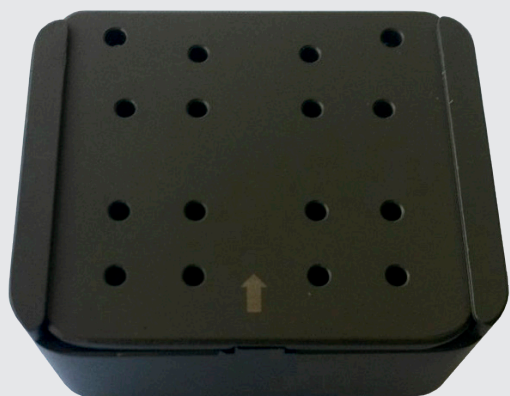

KIT TORNILLOS INJERTO DE HUESO

~~955€~~

715€

COMPUESTO POR:

- Caja para colocar y esterilizar el material 112-061
- Transportador manual de tornillo 1.6 113-MD-101
- Mango 111-010
- Fresa 1.6 112 MD 201
- Fresa 2.0 112-MN 202
- 4 de Tornillos 1.6, 8 unidades 16AT008
- 4 de Tornillos 1.6, 10 unidades 16AT010

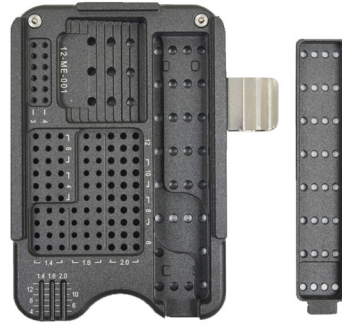

KIT TORNILLOS TÉCNICA ENCOFRADO

~~1.430€~~

1.099€

COMPUESTO POR:

- Caja para colocar y esterilizar el material 112-061
- Mango 111-010
- Transportador manual de tornillo de encofrado 220-0022
- Transportador para CA de tornillo de encofrado 550-50901
- Fresa Tornillo de encofrado 220-0165
- 4 de tornillos 1.2, 8 unidades 204-1208
- 4 de tornillos 1.2, 10 unidades 204-1210
- 4 de tornillos 1.2, 12 unidades 204-1212



KIT CIRUGÍA ENDODÓNICA

- BS-61 - Caja quirúrgica para Instrumental
- SM-15 - Sonda milimetrada a milímetro
- MAB-1 - Mango de bisturí redondo
- 718 133 - Bisturí de Orban
- 718 24G - Periostotomo de Glickman
- 718 PR3 - Periostotomo Prichard
- EP-05 - Separador de papilas
- FD-28 - Portaguñas Castroviejo
- GFC-S - Tijeras Goldman Fox Curvas
- BD-31 - Pinzas Adson S/D
- DA-07 - Pinzas de Corn
- Micro espejo de 3mm

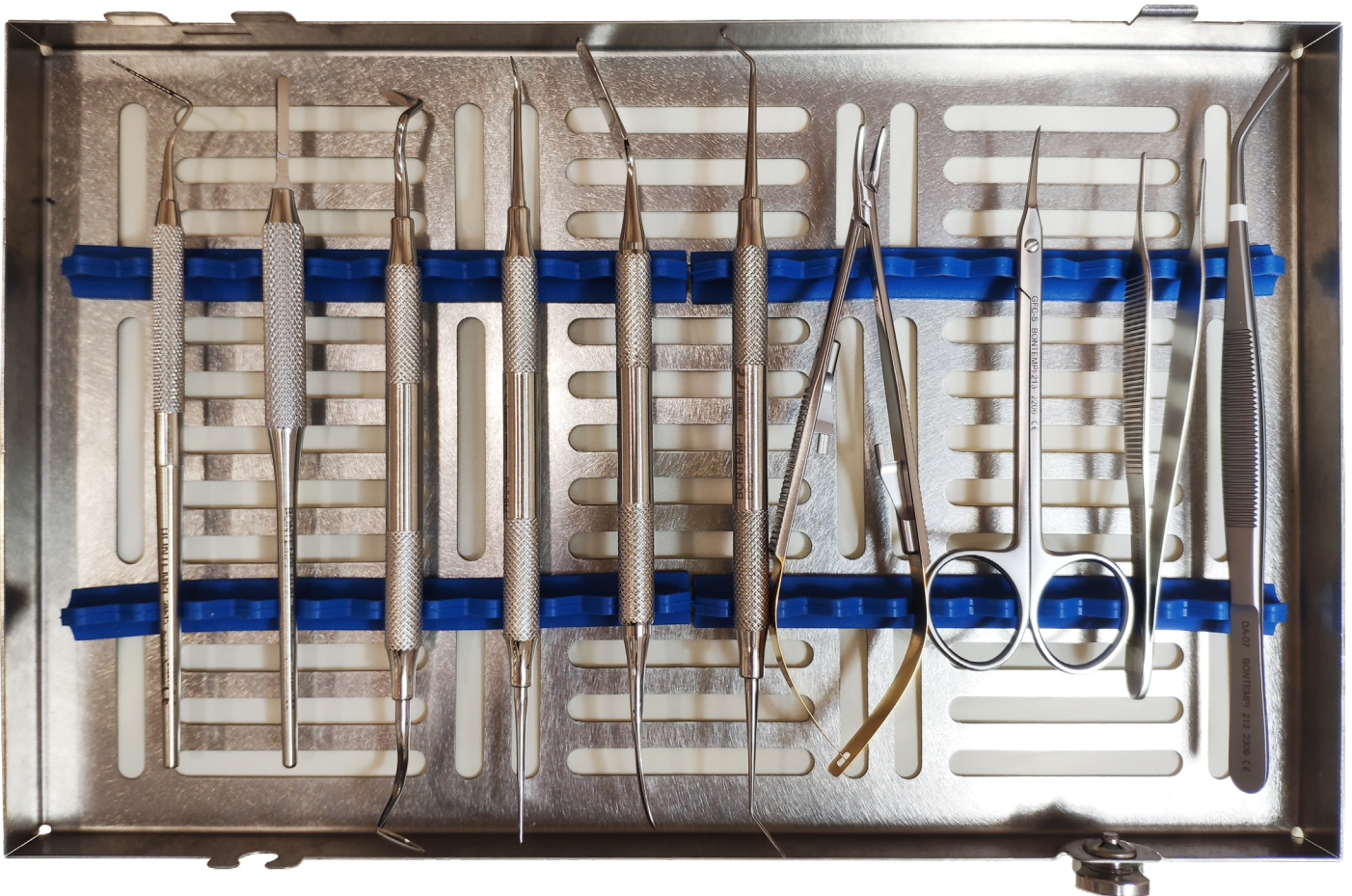

CON Kit Endo Success

1110€

SIN Kit Endo Success

680€

2 PORTAGUJAS PH-70

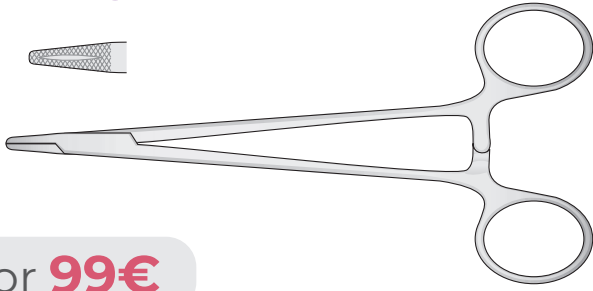

Por **99€**

2 PORTAGUJAS PH-79

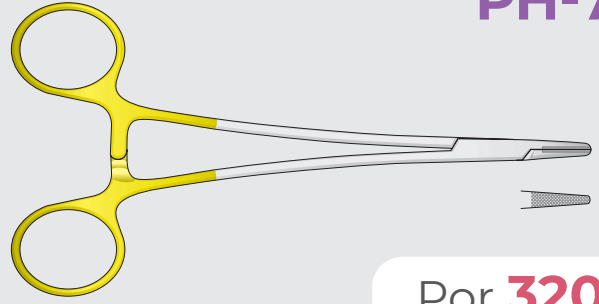

Por **320€**

2 PORTAGUJAS CASTROVIEJO FD-28

Curvos

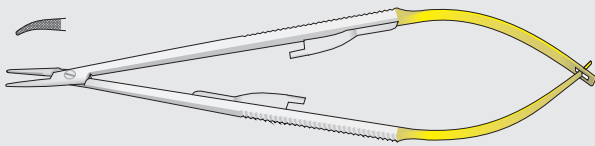

Por **440€**

2 PORTAGUJAS CASTROVIEJO FD-22

Rectos

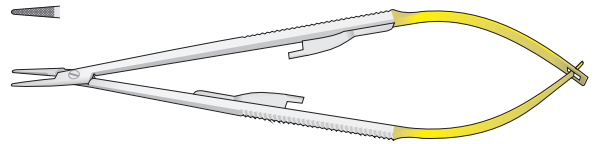

Por **440€**

2 PORTAGUJAS CASTROVIEJO FD-30

Rectos

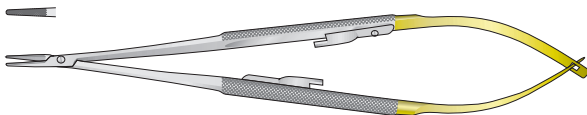

Por **560€**

2 PORTAGUJAS CASTROVIEJO FD-32

Curvos

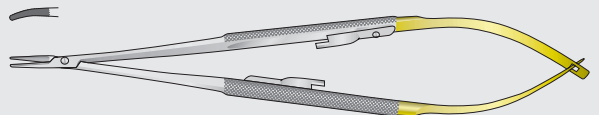

Por **560€**

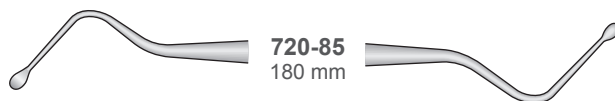

720-85
180 mm

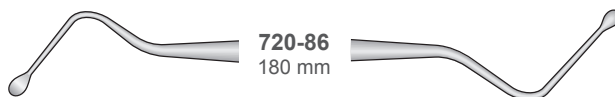

720-86
180 mm

4 CUCHARILLAS LUCAS

A escoger
720-85 y/o 720-86

Por **99€**

4 CUCHARILLAS LUCAS DENTADAS

A escoger
720-85M o 720-86M

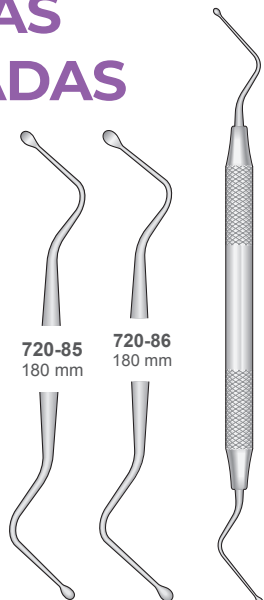

Por **119€**

6 KITS DE 1ª VISITA

Meriam, P-5 + MA-2 y 707 23 D2

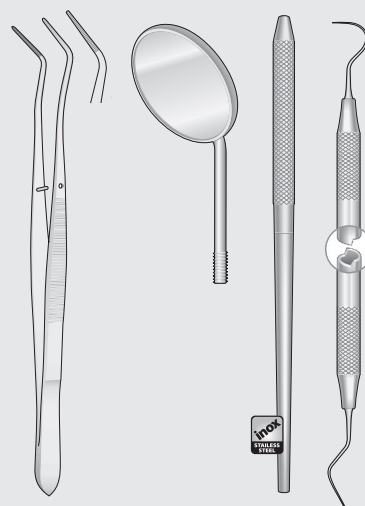

Por **150€**

4 CUCHARILLAS DE DENTINA

A escoger
E-1 y/o E-2

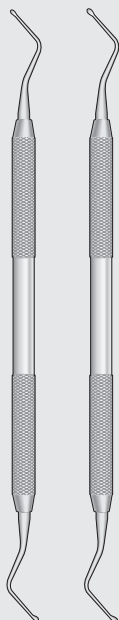

Por **30€**

3 TIJERAS GFC-S

Curvas

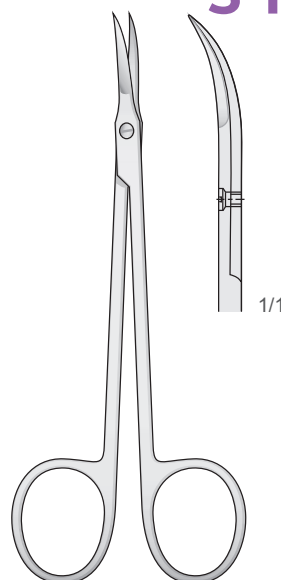

Por **135€**

3 BOTADORES BEIN

A escoger. De 2 mm, 3 mm y/o 4 mm

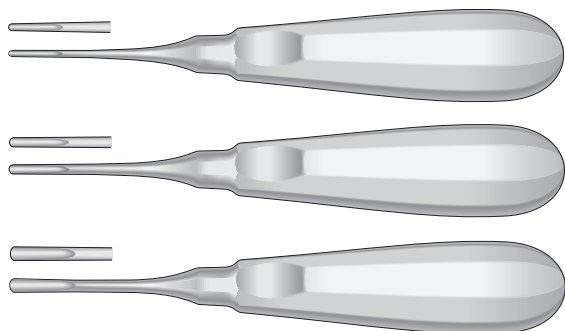

Por **99€**

4 PINZAS MOSQUITO

A escoger. P-91 (recta) y/o P-92 (curva)

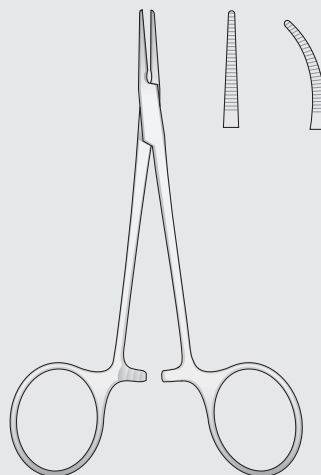

Por **120€**

FORCEPS

1, 7, 51-L, 67-A, 17, 18, 13, 33, 22, 79, 86-A

4 forceps a
escoger por

260€

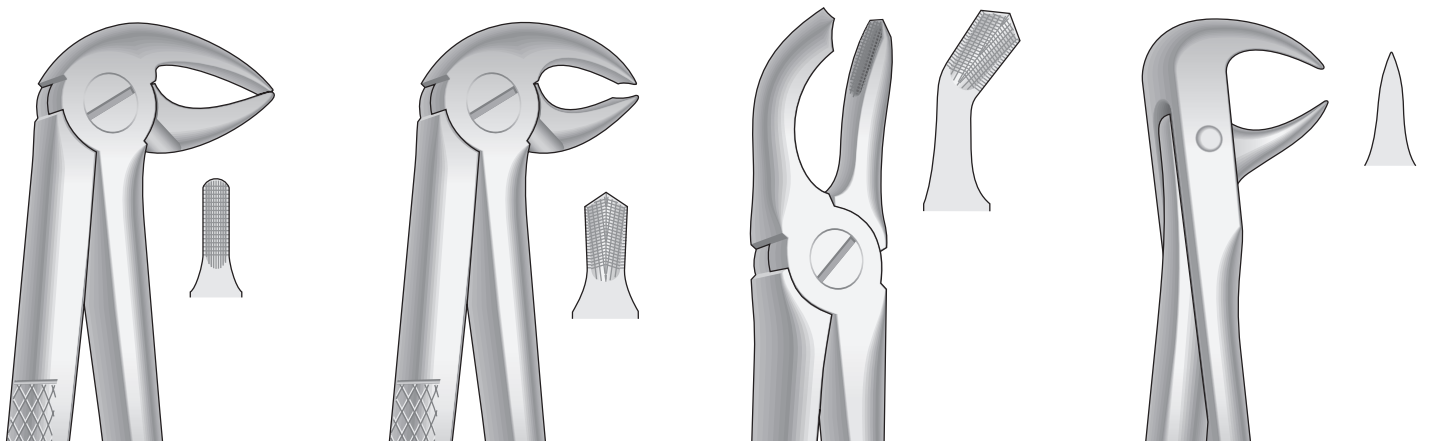
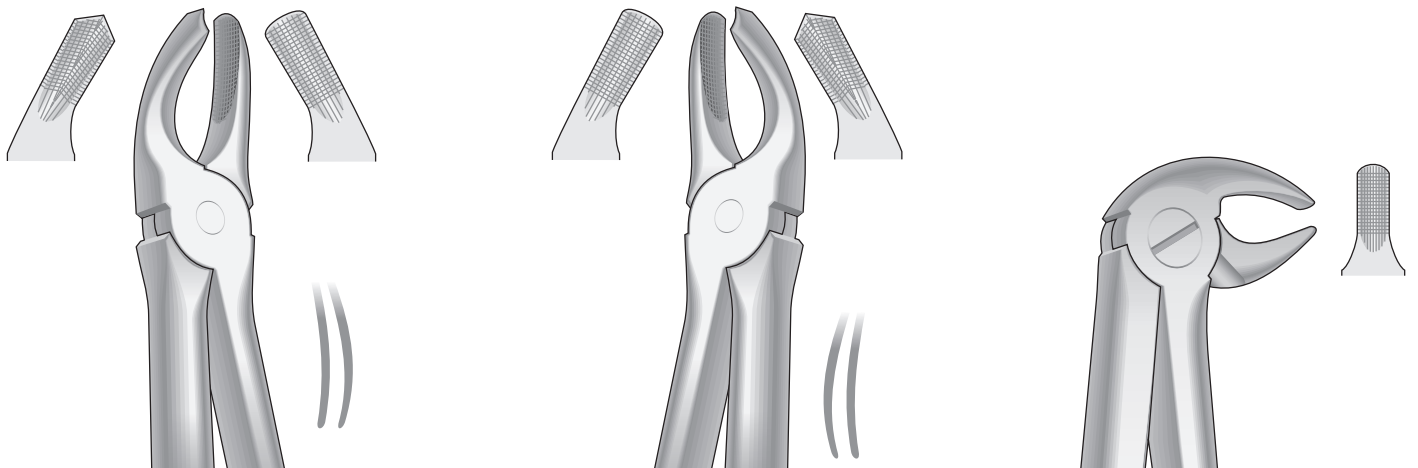
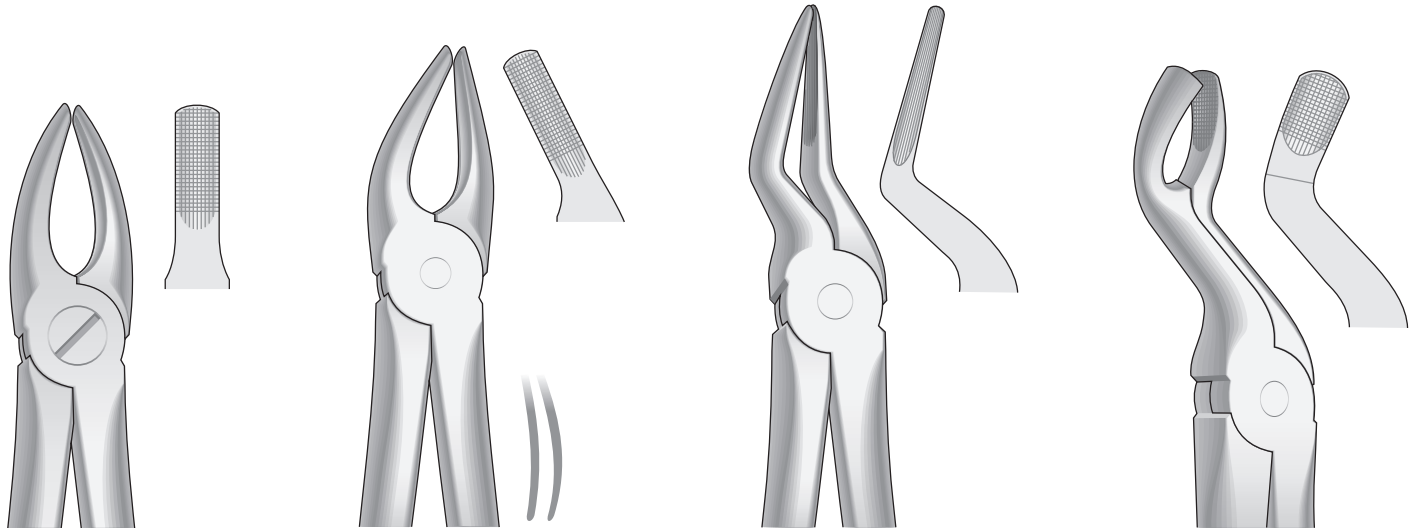

FORCEPS PEDIÁTRICOS

PEB-1, PEB-2, PEB-3, PEB-4,
PEB-5, PEB-6, PEB-7

2 forceps a
escoger por
99€

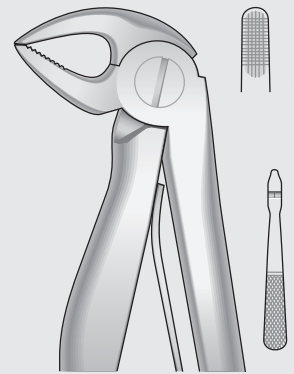
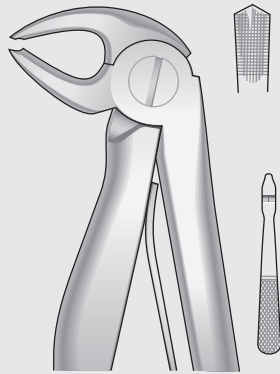
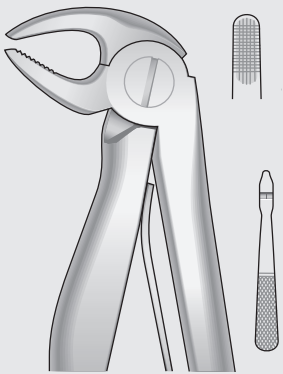
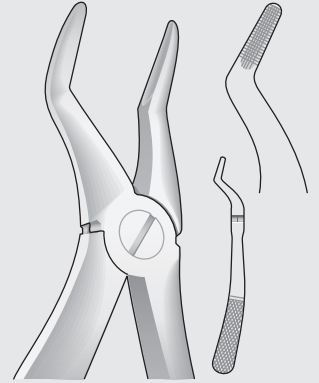
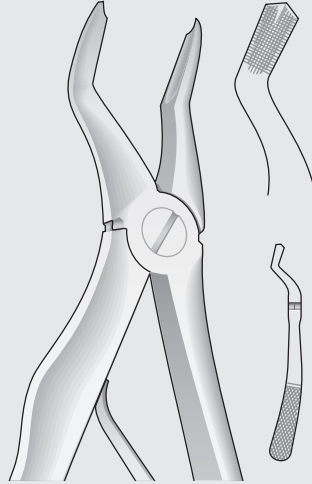
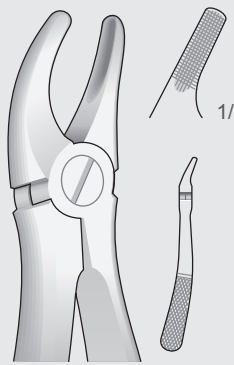
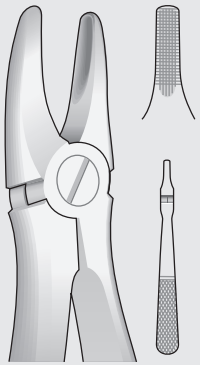

ESPÁTULA DE CEMENTO

3 por **33€**

S-2

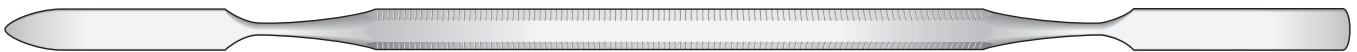

ALICATES DE CORTE

20%
DTO

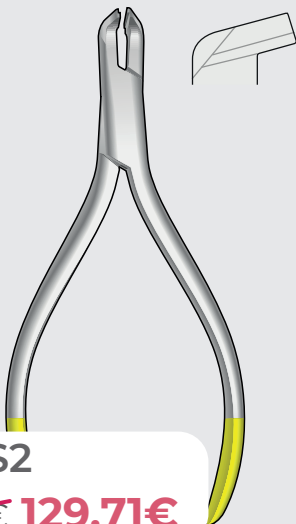

LX-DS2

~~162,14€~~ **129,71€**

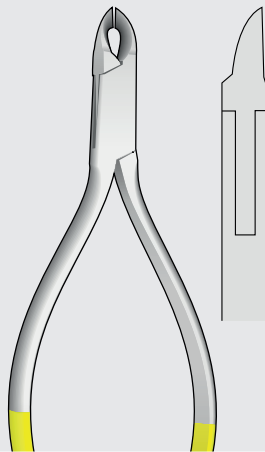

LX-95 TC

~~130,83€~~ **104,66€**

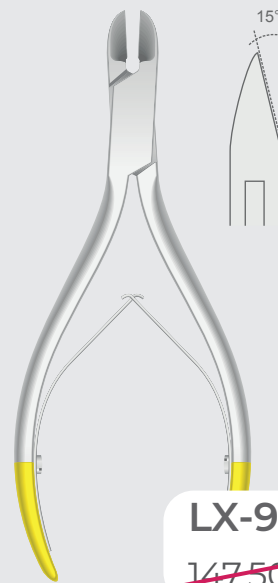

LX-94

~~147,50€~~ **118€**

SEPARADORES

20%
DTO



OM-55
~~41,01€~~
38,81€



OM-90M
~~123,81€~~
99,05€



BT-66
~~82,53€~~
66,02€



BT-154, BT-155
~~97,21€~~
77,77€

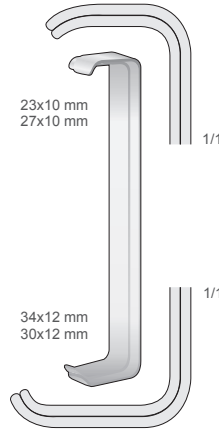

BT-20
~~36,56€~~
29,25€

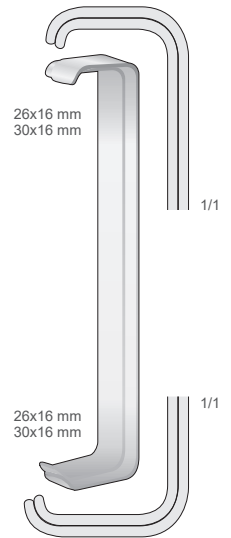

BT-25
~~42,19€~~
33,75€

PERIOSTOTOMOS

20%
DTO

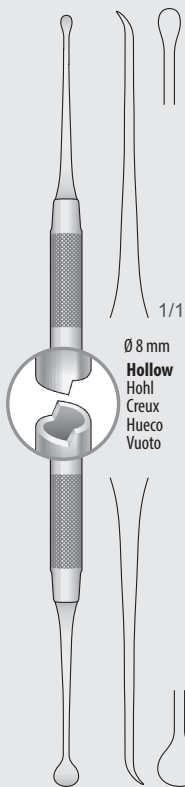

MO-10
~~50,48€~~
40,38€



FREER
~~65,80€~~
52,65€

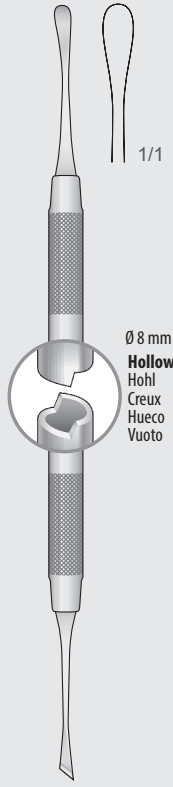

718-24G
~~45,20€~~
36,16€



718-K2
~~44,50€~~
35,60€



718-M9
~~45,20€~~
36,16€

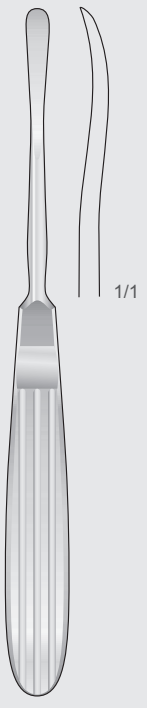

DO-59
~~113,75€~~
91€

ALICATES USO GENERAL

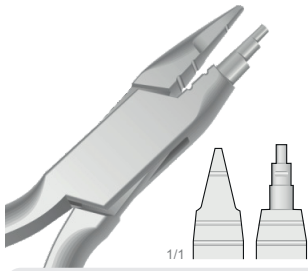

DP-73 ~~103,75€~~ **83€**

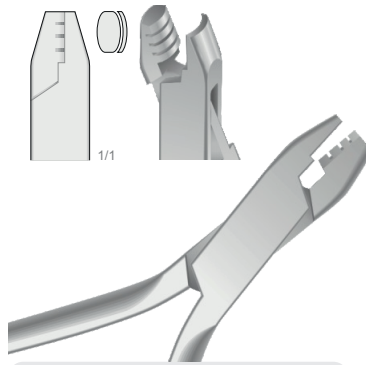

DP-79 ~~137,50€~~ **110€**

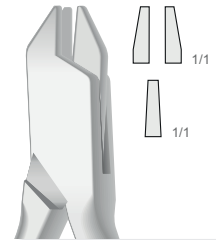

DP-25
~~94,38€~~ **75,50€**

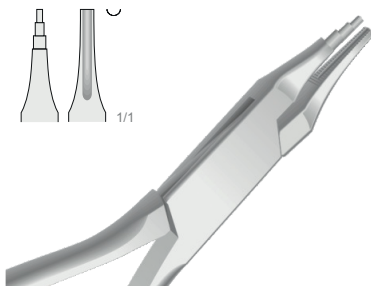

DP-70A ~~101,00€~~ **81€**

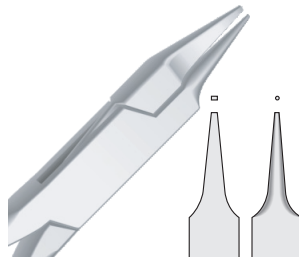

DP-55 ~~68,75€~~ **55€**

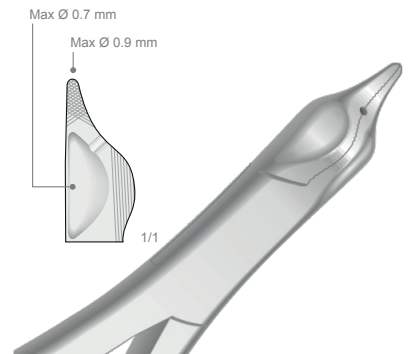

DP-71 ~~56,25€~~ **45€**

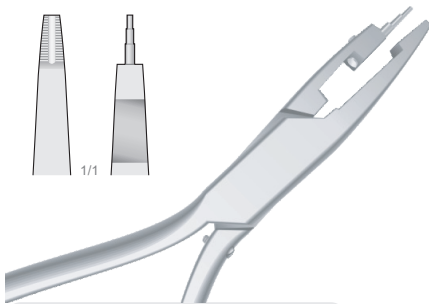

DP-72 ~~153,75€~~ **123€**

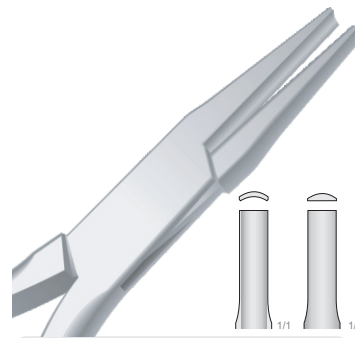

DP-69 ~~93,75€~~ **75€**

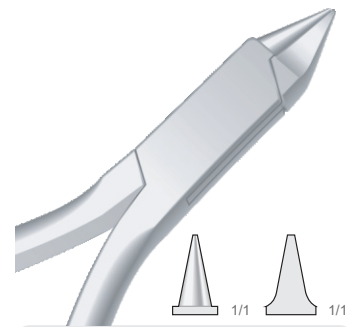

DP-07 ~~101,25€~~ **81€**

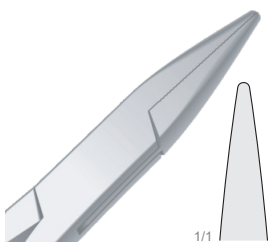

DP-04 ~~94,38€~~ **75,50€**

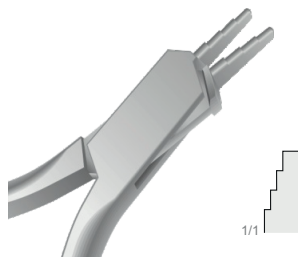

DP-81 ~~97,50€~~ **78€**

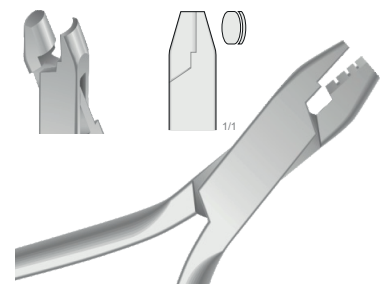

DP-79A ~~125€~~ **100€**

20%
DTO

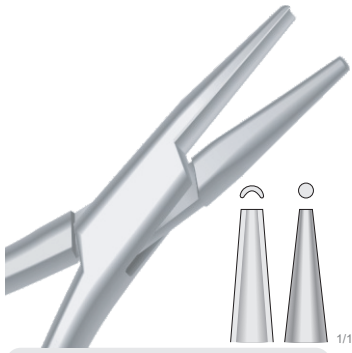

DP-67 ~~76,25€~~ **61€**

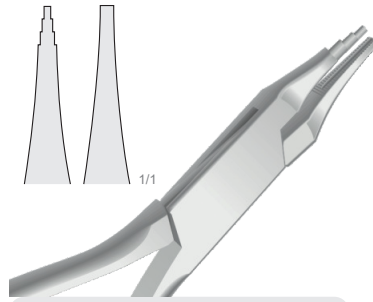

DP-70 ~~93,75€~~ **75€**

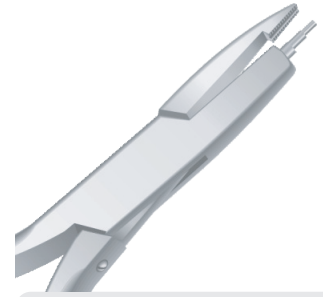

DP-74 ~~96,88€~~ **77,50€**

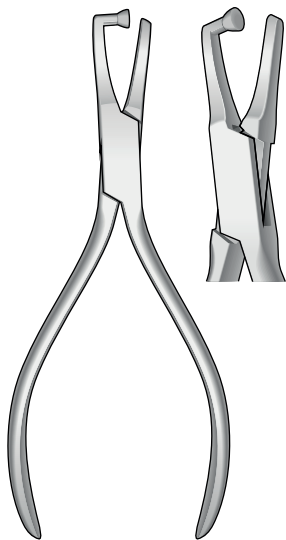

DP-36T ~~93,75€~~ **75€**

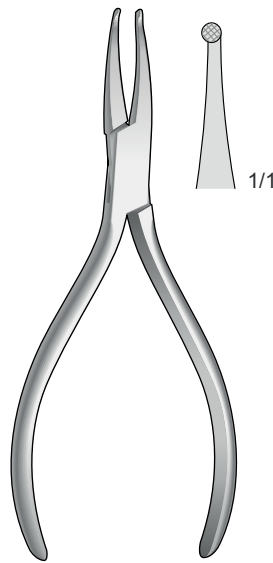

DP-05 ~~78,75€~~ **63€**

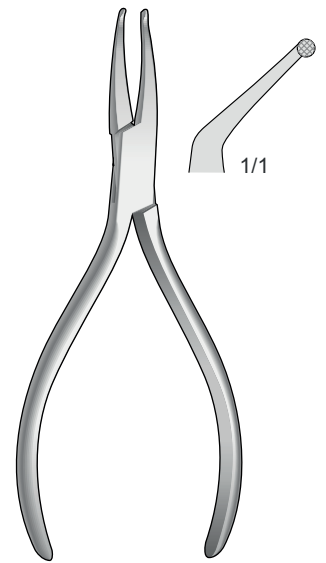

DP-06 ~~81,25€~~ **65€**

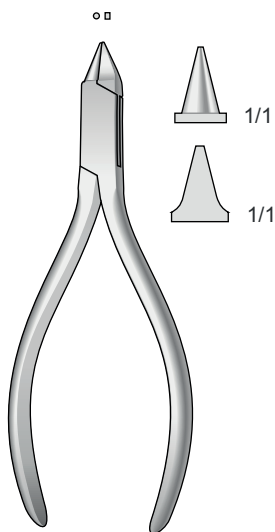

DP-01 ~~102,50€~~ **82€**

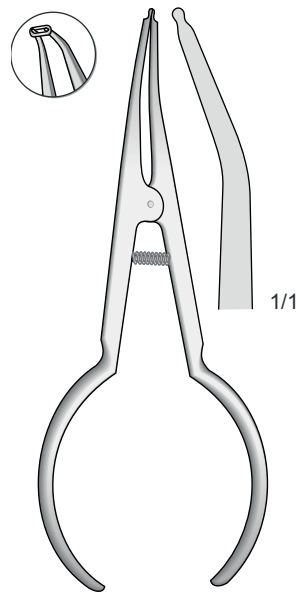

DF-20 ~~94,38€~~ **75,50€**

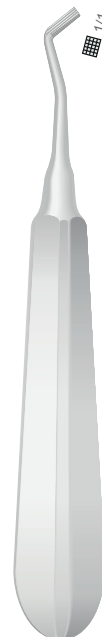

DP-50 ~~45€~~ **36€**



DP-52 ~~20€~~ **16€**



AMERICAN EAGLE INSTRUMENTS® INC

CURETAS XP

Autoafilables, no hay que afilarlas



Gracey normal

1/2 XPX
3/4 XPX
5/6 XPX
7/8 XPX
9/10 XPX
11/12 XPX
13/14 XPX

Columbia

2L-2R XPX
4L-4R XPX
13-14 XPX

Gracey mini

GA 00/0 XPX
GA 1/2 XPX
GA 3/4 XPX
GA 5/6 XPX
GA 7/8 XPX
GA 11/12 XPX
GA 13/14 XPX

49€/cureta

CURETAS TALON

Afilado normal



Gracey normal

1/2 X
3/4 X
5/6 X
7/8 X
9/10 X
11/12 X
13/14 X

Columbia

2L-2R X
4L-4R X
13-14 X

Gracey mini

GA 00/0 X
GA 1/2 X
GA 3/4 X
GA 5/6 X
GA 7/8 X
GA 11/12 X
GA 13/14 X

43€/cureta

SCALERS



Black Jack



AESET XPS



AESEC XPS



AESJ3 U5X



Younger Good

49€/unidad

CURETAS TITANIO



AEIIN128 L5X



AEIIB5-6X

60€/unidad

DIRECTA

LUXATOR

L2S, L3S, L3C, L5S y/o L5C

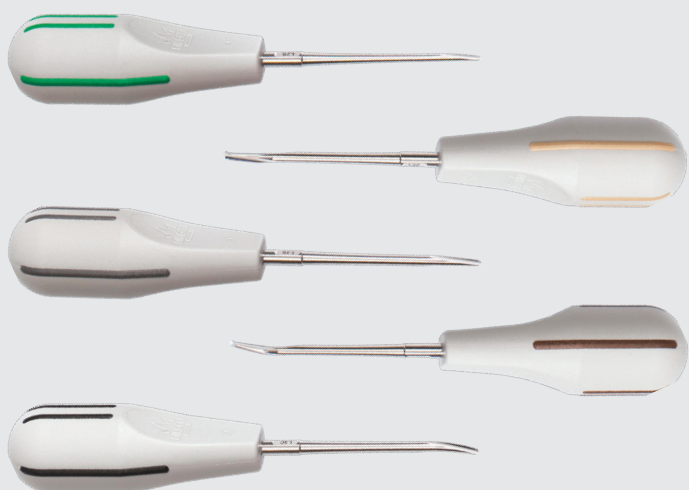

4 a escoger
por **300€**

LUXATOR P-SERIES

P1, P2, P3 y/o P4



4 a escoger
por **300€**

LUXATOR DUAL EDGE



100€/unidad

PAPEL ARTICULAR

Rojo y/o azul



2 Cx100 a escoger por 50€

parkell®

PREDICTA DESENSITIZER

1 jeringaa x 3 ml de gel
desensibilizante + 10 puntas
aplicadoras + 15 micropinceles



2 por 90€

DRYZ BLU

7 Jeringas de 0,5ml + 15 puntas

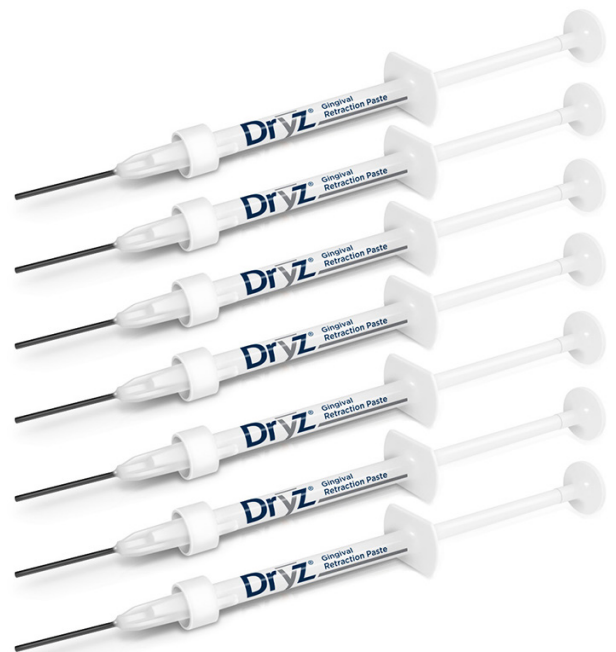

Por 75€

INSERTS

1, 2, 10P y/o 10X



4 a escoger
por **150€**

INSERTS

IP1 y/o H3



2 a escoger
por **110€**

NSK

Para acceder a las ofertas de NSK, por favor visite nuestra web www.bontempi.es o escanee el código qr a continuación:



Intensiv
Swiss Dental Products

Para acceder a las ofertas de Intensiv, por favor visite nuestra web www.bontempi.es o escanee el código qr a continuación:



HOJA DE MICROCIRUGÍA

SB003: Maleable, fantástica para tunelación
Caja de 10 unidades



69€/caja



META

SAFESCRAPER

3 botes de 3 unidades

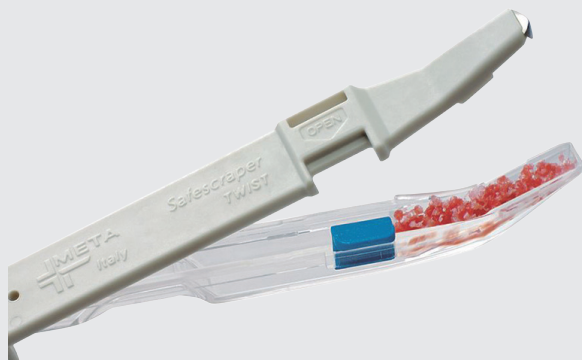

Por **285€**

MICROSS

6 unidades



Por **300€**